

LBL03RE940CI

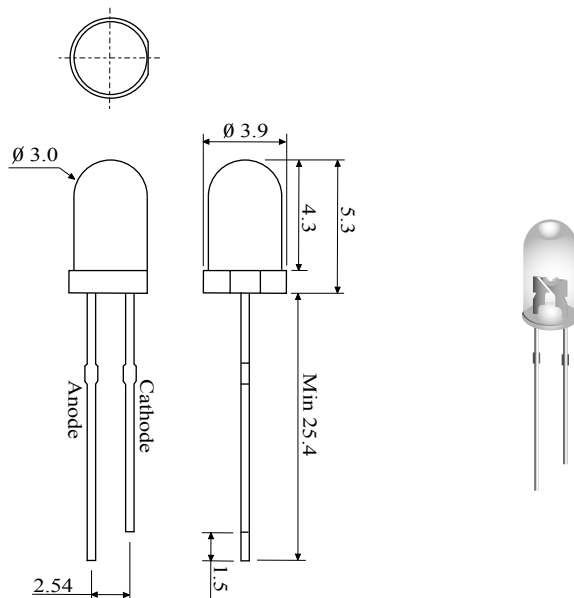

NOTE TOLERANCE +/- 0.2mm

- * ABSOLUTE MAXIMUM RATINGS: (Ta=25°C)
- * OPERATING TEMPERATURE: -55°C TO + 100°C
- * LEAD SOLDERING : 260°C FOR 5 SECONDS

PARAMETER	TEST CONDITION	Symbol	MIN.	TYP.	MAX.	UNIT
REVERSE BREAK DOWN VOLTAGE	IR=100uA	BvR	30			v
REVERSE DARK CURRENT	VR=10V	Id			30	nA
LIGHT CURRENT	VR=5V	In		60		uA
POWER DISSIPATION		Pd		100		mW
WAVELENGTH OF PEAK SENSITIVITY		λ p		940		nm
RANG OF SPECTRAL BANDWIDTH		λ0.5		400-1200		nm