

### LR07W ( 0.5 )

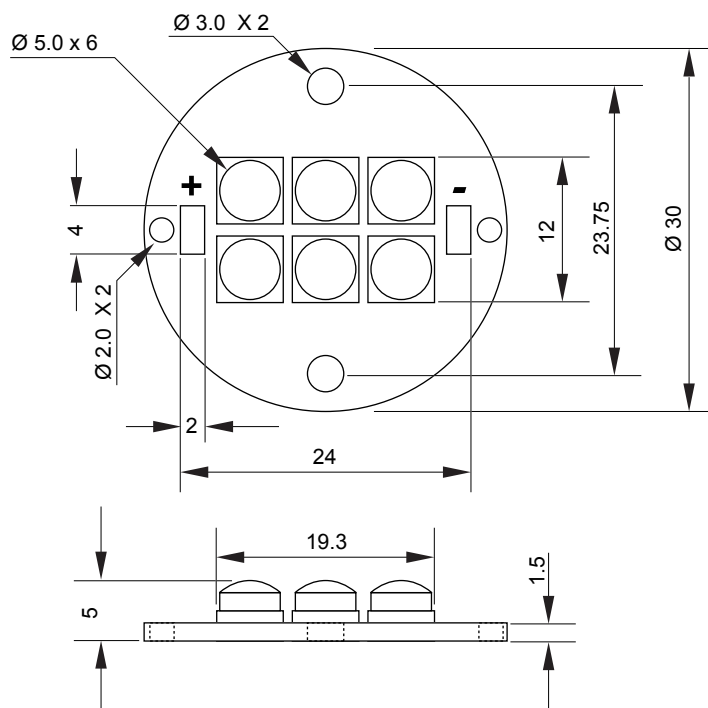

#### Absolute Maximum Rating at (Ta=25°C)

Parameter	Symbol	Maximum Rating	Unit
Power Dissipation	Pd	3	W
Forward Current	If	260	mA
Forward Voltage	Vr	9.5	V
Operating Temperature Range	Topr	- 40 °C to + 85 °C	
Storage Temperature Range	Tstg	- 40 °C to + 85 °C	
Solder Temperature 1/16 Inch Below Seating Plane for 3 seconds at 260 °C			

\* Condition for Ifp is pulse of 1/10 Duty Cycle, 0.1ms Pulse Width

#### Electrical/Optical Characteristics at Ta=25°C

Parameter	Symbol	Condition	Min	Typ	Max	Unit
Forward Voltage	Vf	If=20mA		9.5		V
Reverse Current	Ir	Vr=5V			100	uA
Dominant Wavelength	d	If=20mA				nm
Peak Wavelength	p	If=20mA				nm
Viewing Angle	2	If=20mA		120		dfg